

- Navien **Ready-Link® Rack V3** system can be used to mount a single or multiple water heater or boiler units that are connected to a cascade system

- This accessory is **compatible** with the following Navien models:

NPE-A, NPE-S* Series Tankless Water Heaters

NPN Series Tankless Water Heaters

NCB-E Series Combination Boilers

NHB Series Heating Boilers

NFB-175/200 Fire Tube Heating Boilers

NFC-175/200 Fire Tube Combination Boilers

** Rack systems with NPE Series models are rated for both **INDOOR** and **OUTDOOR** installations*

- Recommended** for systems that are located in tight spacing or in areas without enough available wall spacing.

- Designed** to hold water heater and boiler units as well as common water and gas piping

- Dimensions:** See below illustration









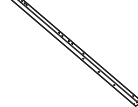

- Weight:** 48.0 lbs (21.8 kg) per **BASE** Kit, 24.0 lbs (10.9 kg) per **ADD-ON** Kit

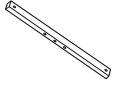
- Navien Part Number(s):** **GFFM-KDIZUS-005** (**BASE** for single or 2 units back-to-back)

GFFM-KDIZUS-006 (**ADD-ON** extension kit for 2+ units in-line or 3+ units back-to-back)

- Warranty:** 1 Year

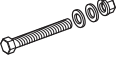
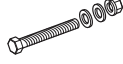
- The Navien **Ready-Link® Rack V3** includes the following items:

						
Installation Guide 1 EA	Post bar 64.4 in * Single kit: 2 EA ** Extension kit: 1 EA	Fixed bar 17.7 in * Single kit: 2 EA ** Extension kit: 2 EA	Base frame 32 in * Single kit: 2 EA ** Extension kit: 1 EA	Fixed bracket (under) * Single kit: 4 EA ** Extension kit: 2 EA	Fixed bracket (middle) * Single kit: 4 EA ** Extension kit: 4 EA	Fixed bracket (upper) * Single kit: 2 EA ** Extension kit: 2 EA
						
Reinforcement plate * Single kit: 4 EA ** Extension kit: 2 EA	Tapping screw 5x12 (washers set, stainless steel)† * Single kit: 20 EA ** Extension kit: 12 EA	Tapping screw 5x12 (stainless steel)† * Single kit: 2 EA ** Extension kit: 2 EA	M10 bolt (3 in, stainless steel) * Single kit: 22 EA ** Extension kit: 14 EA †	M10 bolt (2.8 in, stainless steel) * Single kit: 3 EA ** Extension kit: 3 EA	5/32 in or 4 mm Allen wrench 1 EA	

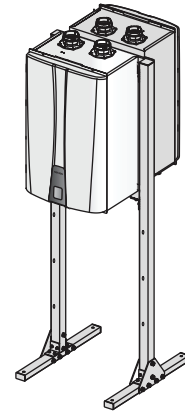

NEW! Compact Design with In-line or Back-to-Back Setup

Dimensions

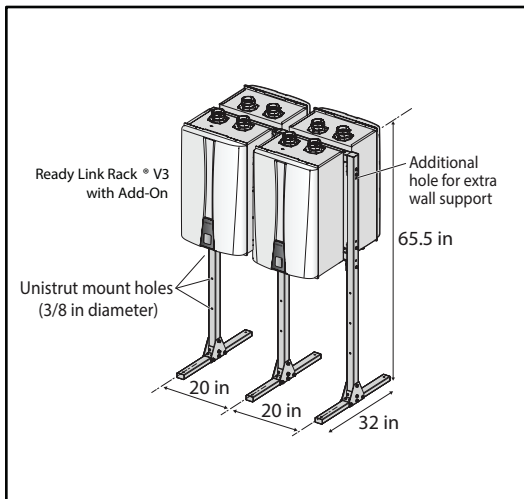

Installation Examples

